

Round Blue Through-hole LED Lamp (3mm)

OVLBB4C7

- High Brightness with Well-defined Spatial Radiation Patterns
- UV-resistant Epoxy Lens
- Blue (470nm)

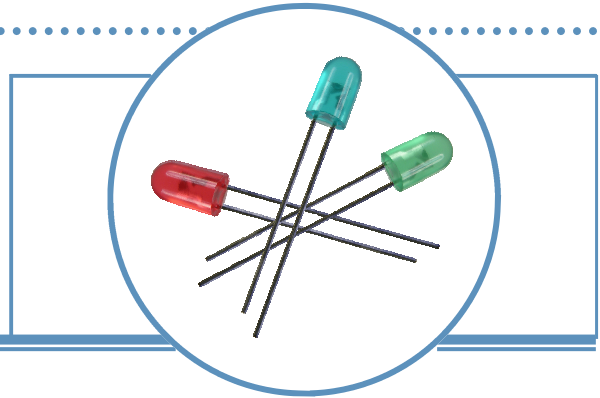

The OVLBB4C7 is a high-intensity InGaN LED mounted in a clear plastic T-1 package. Its UV-resistant epoxy lens makes this device an optimal solution for outdoor applications. This LED provides a well-defined and even emission pattern.

Applications

- Pedestrian Signals
- Signage and Architectural Lighting
- Backlighting
- Automotive

Part Number	Material	Emitted Color	Intensity Typ. mcd	Lens Color
OVLBB4C7	InGaN	Blue	900	Water Clear

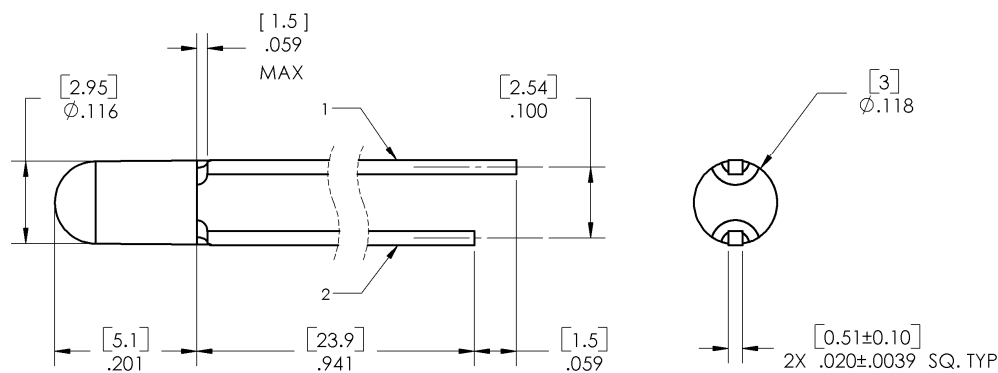

1 ANODE 2 CATHODE DIMENSIONS ARE IN INCHES AND [MILLIMETERS].

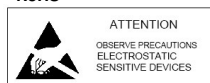

OPTEK reserves the right to make changes at any time in order to improve design and to supply the best product possible.

Round Blue Through-hole LED (3mm) OVLBB4C7



Absolute Maximum Ratings

T_A = 25°C unless otherwise noted

Storage Temperature Range	-40 ~ +100°C
Operating Temperature Range	-40 ~ +85°C
Reverse Voltage	5 V
Continuous Forward Current	20 mA
Peak Forward Current (10% Duty Cycle, 1KHz)	50 mA
Power Dissipation	80 mW
Current Linearity vs. Ambient Temperature	-0.2 mA/°C
LED Junction Temperature	125°C
Lead Soldering Temperature (3mm from the base of the epoxy bulb) ¹	260°C

Note:

- Solder time less than 5 seconds at temperature extreme.

Electrical Characteristics

T_A = 25°C unless otherwise noted

SYMBOL	PARAMETER	MIN	TYP	MAX	UNITS	CONDITIONS
I _v	Luminous Intensity	525	900	----	mcd	I _F = 20mA
V _F	Forward Voltage	----	3.4	4.0	V	I _F = 20mA
I _R	Reverse Current	----	----	50	μA	V _R = 5V
λ _P	Peak Wavelength	----	466	----	nm	I _F = 20mA
λ _D	Dominant Wavelength	465	470	475	nm	I _F = 20mA
2Θ _{1/2} H-H	50% Power Angle	----	45	----	deg	I _F = 20mA

Standard Bins (I_F = 20mA)

Lamps are sorted to luminous intensity (I_v) and dominant wavelength (λ_D) bins shown. Orders for OVLBB4C7 may be filled with any or all bins contained as below.

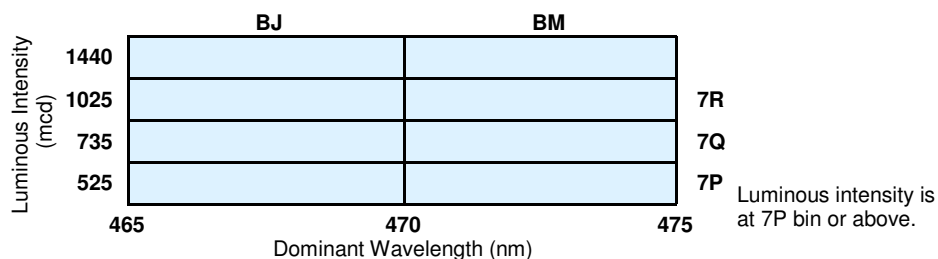

Forward Volt-

Rank	H	J	K	L
Voltage	2.6-3.0	3.0-3.3	3.3-3.6	3.6-4.0

Important Notes:

- All ranks will be included per delivery, rank ratio will be based on the chip distribution.
- To designate luminous intensity ranks, please contact OPTEK.
- Pb content <1000PPM.

Beam Pattern

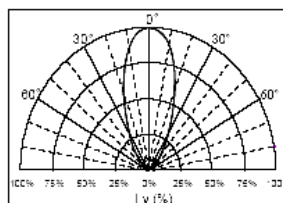

Typical Electro-Optical Characteristics Curves

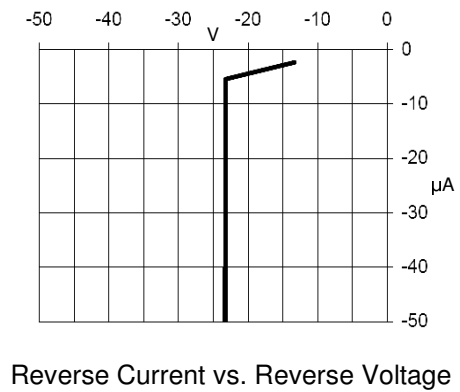
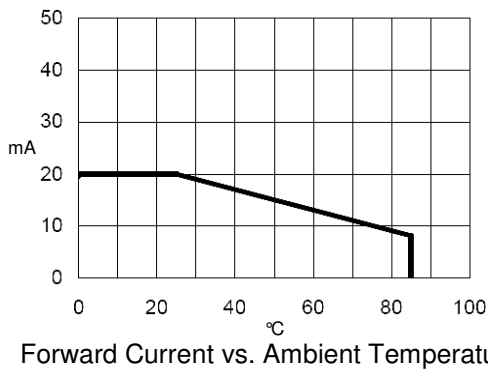
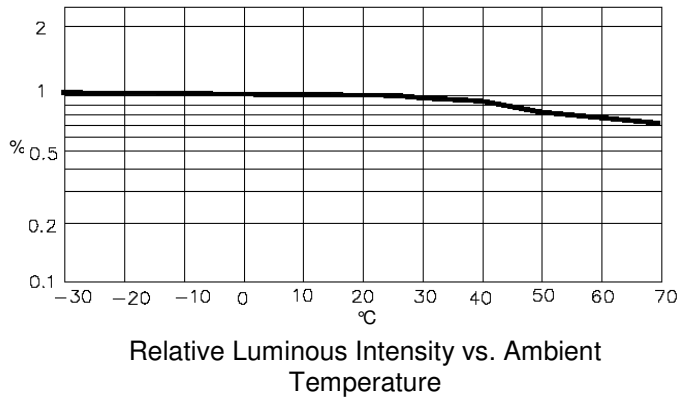
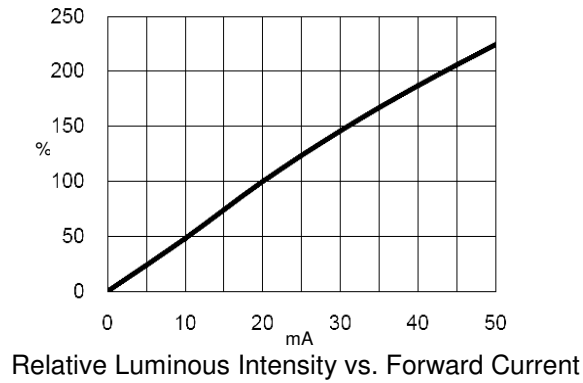
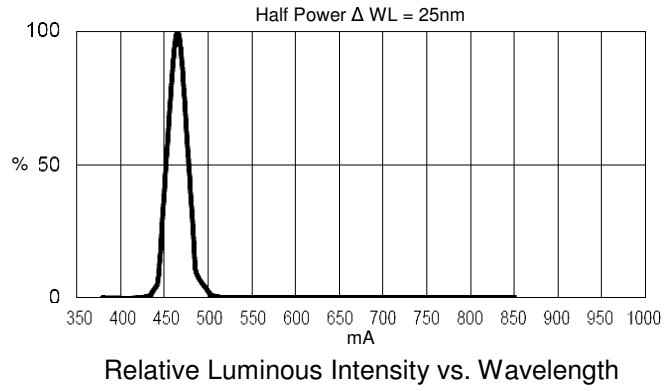
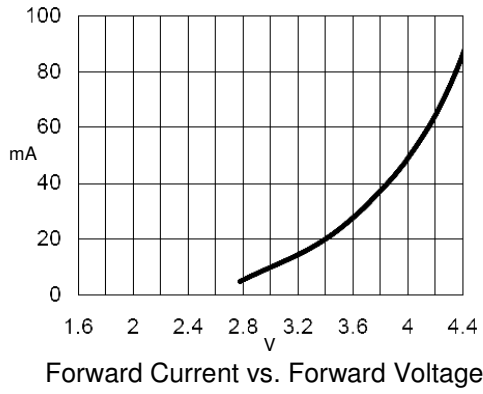

Round Blue Through-hole LED (3mm) OVLBB4C7

Packing Information: Available in Bulk or Reel

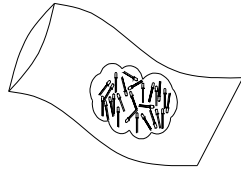

Bulk: 500 pcs/bag

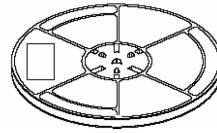

13-Inch Reel: 2500 pcs/reel

Carrier Tape Dimensions

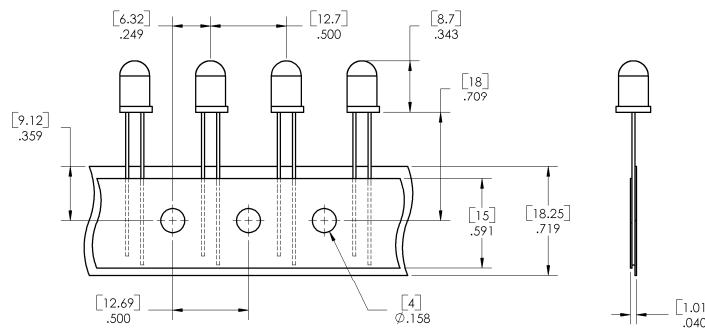

DIMENSIONS ARE IN INCHES AND [MILLIMETERS].

Moisture Resistant Reel Packaging

